



HECKLER & KOCH

NO COMPROMISE

HK 417 D

ELECTRIC AIRSOFT / cal. 6 mm

powered by **UMAREX**® www.umarex.com

UMAREX HOLDS THE WORLDWIDE EXCLUSIVE
HK-TRADEMARK AND EXTERIOR DESIGN
COPY LICENSE FOR USE WITH THIS PRODUCT,
GRANTED BY HECKLER & KOCH GMBH.



2.5945 / 2.5945X



2.6319 / 2.6319X

EN Operating instructions 2 - 8

FR Mode d'emploi 16 - 22

D Bedienungsanleitung 9 - 15

ES Manual de instrucciones 23 - 29



SAFE GUN HANDLING

EN



DESCRIPTION



OPERATION



MAINTENANCE



SAFETY INSTRUCTIONS

You should be fully familiar with the proper and safe handling of your gun. The basic principles of gun safety require you to always apply the following rules when handling the firearm.

- Always treat a gun as if it was loaded.
- Always put the safety of a gun to "safe" when loading it so that there can be no unintentional discharge.
- Keep your finger away from the trigger. It should be straight and should rest on the trigger guard.
- Only use the kind of projectiles suitable for your gun.
- Always keep the muzzle pointed in a safe direction.
- This gun may only be discharged in your own house, on authorized shooting ranges and inside enclosed private property. It is to be made sure that no projectile can leave the enclosed property.
- Keep the danger area of the projectile in mind.
- Never transport a loaded gun. Only load your gun when you intend to fire it.
- Never aim your airgun at persons or animals. Avoid ricochets. Never fire at smooth, hard surfaces or water.
- Before you discharge your gun, make sure that target and surrounding area are safe.
- Always make sure that the gun is not loaded when you transport it or take it from another person.
- Make sure that you always have full control over the muzzle of your gun, even if you stumble or fall down.
- Safety shooting glasses should always be worn when firing the gun.
- Always store your gun in a safe place and in unloaded condition. Unauthorized persons (persons not familiar with the use of guns, children) must not have access to it. Ammunition is to be kept in a separate place.
- This gun and its instruction manual may only be passed on to persons
 - who are fully familiar with its use and
 - who have reached the legally stipulated minimum age in the respective country.
- Modifications or repairs of guns are only to be effected by authorized agencies or by a skilled gunsmith.
- Never leave a loaded gun unattended.
- Only unloaded guns are to be handed over to another person.

REPAIR

A gun that does not work properly is dangerous. Do not attempt to repair this pistol if it needs service. Incorrect assembly could lead to dangerous malfunctions.

Caution: Repairs should only be completed by UMAREX authorized centres.

 **Note on batteries:** Batteries must not be exposed to excessive sources of heat such as sunshine, fire or similar. Only rechargeable batteries may be charged. It is unlawful to dispose of used batteries along with common household waste. You are obligated to dispose of old batteries (free of charge) at a public collection point, a business which will accept their return or at a technical customer service location. Used primary and secondary (rechargeable) batteries contain high percentages of reusable substances, so-called "recoverable resources". By ensuring their recovery through appropriate recycling processes instead of combining them with common waste materials, you make a contribution in preserving important resources and protecting the environment from harmful heavy metal substances. Batteries containing pollutants are marked with the symbol of a crossed-out garbage can and a chemical symbol (Cd, Hg or Pb) which is essential for classification of the polluting heavy metal. Please contact your local authorities for information about disposal facilities.

For lithium-based primary and secondary batteries: Only dispose of completely discharged batteries. If a battery is not completely discharged, precautions must be taken to prevent short circuiting its terminals, e.g. isolation of the terminals.



SAFETY INSTRUCTIONS | WARRANTY



CAUTION

For your own safety and the safety of others, carefully read these instructions before using this gun. Buyers and owners must observe all rules concerning the use and ownership of air guns. Modifying this gun may result in a change of its classification under guns law and is therefore prohibited. In such cases the manufacturer's warranty will immediately become void.



WARNING

Do not brandish or display this airgun in public - it may confuse people and may be a crime. Police and others may think this airgun is a firearm. Do not change the coloration and markings to make it look more like a firearm. That is dangerous and may be a crime.

WARRANTY

During the legal warranty period, which begins on the date of purchase, UMAREX will repair or replace your gun at no charge provided the defect was not caused by you. Return your gun to an authorized dealer along with a description of the problem and proof of purchase.

The air guns manufactured by UMAREX Sportwaffen GmbH & Co. KG are made according to the regulations of the PTB (Physikalisch-Technische Bundesanstalt), German federal law, the CIP regulations and the technical know-how of UMAREX Sportwaffen GmbH & Co. KG.

We will not assume any liability whatsoever if this product is exported to territories outside of Germany and as a consequence does not comply with domestic legal requirements of these territories. It will be the sole responsibility of the importer to ensure compliance with local laws and regulations.

TECHNICAL DATA

Item no.	2.5945	2.5945X	2.6319	2.6319X
System	Electric Airsoft			
Caliber/Ammo	6 mm BBs			
Capacity	100 rounds (BBs)			
Energy	1,3 J max.	1 J max.	1,3 J max.	1 J max.
Velocity	up to 110 m/s with 0,20 g BB	up to 100 m/s with 0,20 g BB	up to 110 m/s with 0,20 g BB	up to 110 m/s with 0,20 g BB
Drive	Semi-Auto	Semi + Voll-Auto	Semi-Auto	Semi + Voll-Auto
Rate of fire	-	1000 rpm	-	1000 rpm
Color	black			
Safety	manual			
Barrel length	365 mm		420 mm	
Dangerous area up to	150 m		150 m	
Weight	3500 g		3793 g	
Length	805 mm - 886 mm		906 mm - 989 mm	



DESCRIPTION

EN

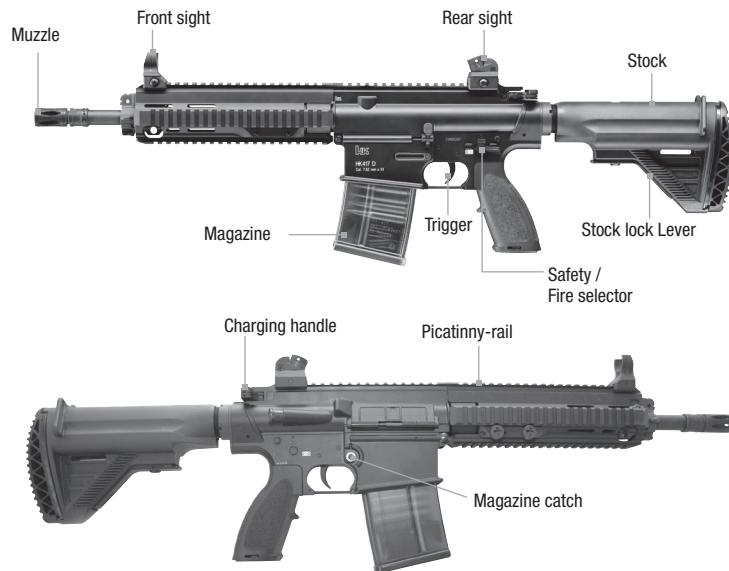



SAFETY

EN

⚠ CAUTION

- Only handle your gun in its safe condition.
- Always make sure that the muzzle points in a safe direction.



Full-auto-version 2.5945X / 2.6319X

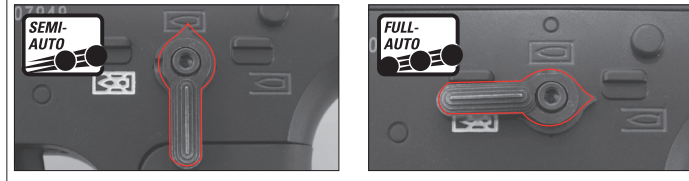

⚠ CAUTION

Please also always observe the legal regulations effective in your country for the use of arms.

Semi-auto-version 2.5945 / 2.6319

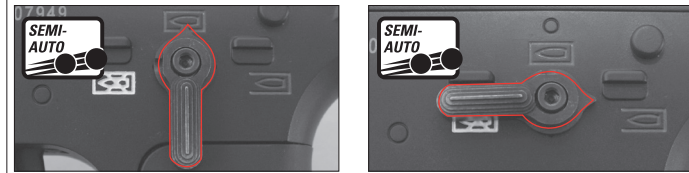

⚠ CAUTION

Please do not switch the fire selector while pulling the trigger. This causes severe damage to your gun.



SHOOTING



PROBLEM SOLUTIONS



PROBLEMS

Faulty shooting direction				●	●	●	●	●	
Gun does not shoot	●	●	●			●	●		
Low shooting speed				●	●	●	●		

POSSIBLE CAUSES

	Safety activated	cock the magazine again	Battery / Magazine empty	Dirty barrel	Extreme temperatures	Wrong ammunition	Ammunition badly loaded	Sight not properly adjusted	



INLAYING RECHARGEABLE BATTERY

EN

CAUTION

- When batteries are almost empty they can cause gearbox malfunctions that require repair.
- Batteries should never be overdischarged. This can damage the cell.
- Prolonged overcharging causes permanent damage to batteries.
- The battery should always be drained before charging.
- There is no warranty for batteries, because they are wear parts. Use only those batteries of 9,6 V (e.g. Article-No.: 2.6003) (Crane Stock) or LiPo batteries.

Please note that flat batteries must not be put in the household waste. Dispose of them properly, hand them in at your local shop for disposal or take them to a used battery collection location.

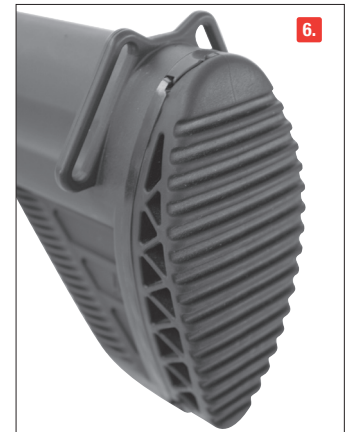
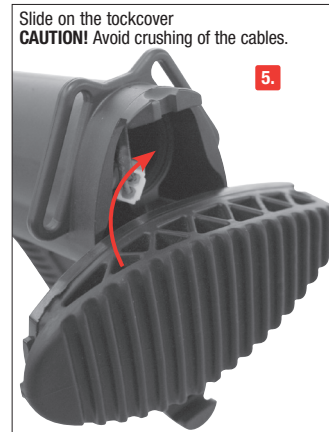
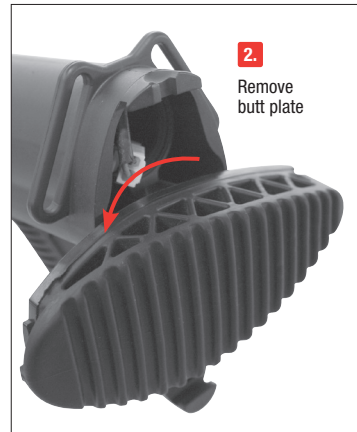



LOADING THE MAGAZINE

EN

⚠ CAUTION

Only use flawless BBS. Never use the following BBS: ❶ diameter larger than 6mm, ❷ with edges, ❸ both halves not aligned, ❹ used, soiled. Warranty expires if non-recommended BBs are used. It's recommended to use precision BBs from UMAREX/Walther. To ensure proper operation of the magazine, protect it from dirt and dust.

6 mm AIRSOFT	WEIGHT 0,2 g BB	WEIGHT 0,25 g BB
------------------------	---------------------------	----------------------------

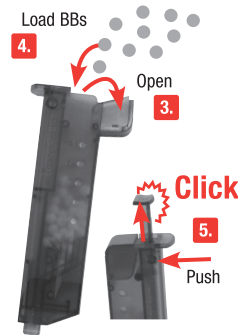

 SIGHTS

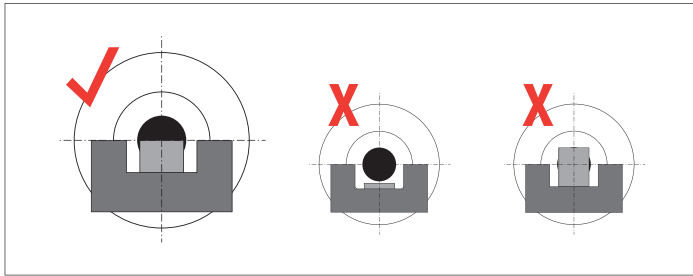

 ADJUSTABLE REAR SIGHT

2.5945 / 2.5945X

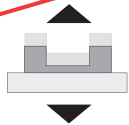
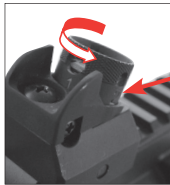

Height adjustment

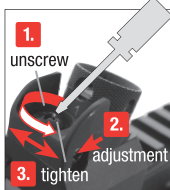

- 1: open rearsight
- 2: long shooting distance
- 3: medium shooting distance
- 4: short shooting distance

Windage adjustment



- Shoot too far left  turn to the right
- Shoot too far right  turn to the left

 SIGHTS

EN

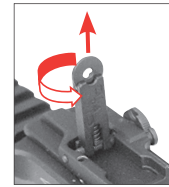

2.6319 / 2.6319X

Height adjustment



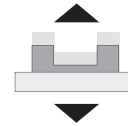

- 1. Pull Rear sight
- 2. Turn Rear sight



- Shots are too high  turn to the right
- Shots are too low  turn to the left

Windage adjustment



- Shots are too low  turn to the right
- Shots are right of center  turn to the left



ADJUSTABLE SHOOT UP

Pull back the charging handle and push it forward.

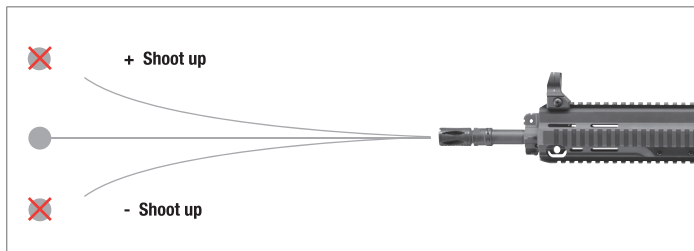
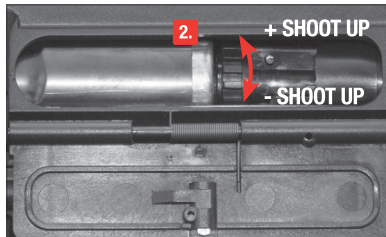

STOCK

EN

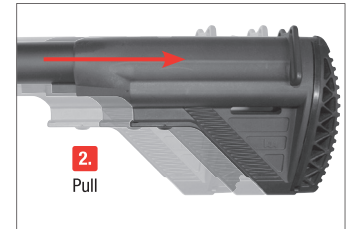
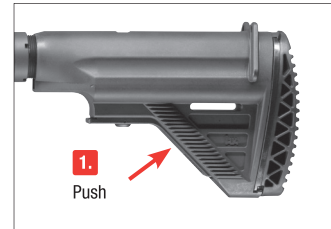

BARREL CLEANING



CAUTION

- Unload the gun before cleaning the gun.
- Do not force the rod into the barrel, as this could cause damage.
- Occasionally clean the metal parts on the outside. Use a cloth which has been slightly dampened with some gun oil.
- Never drip silicone oil directly into the barrel.

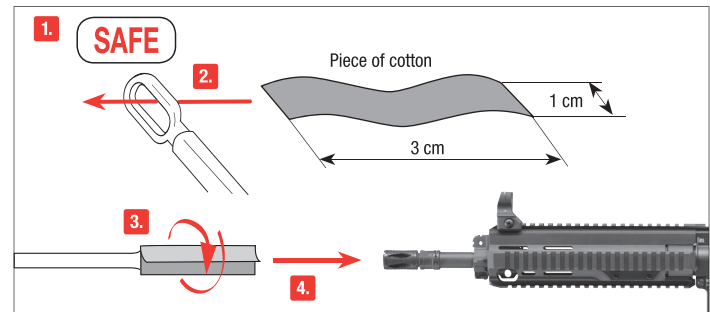

Put the safety on "safe". Prepare a thin rod with a length of approx. 30 cm. Attach a piece of cotton fabric to its end and clean the barrel with some silicone oil.



SICHERER UMGANG MIT WAFFEN

DE



BENENNUNG



BEDIENUNG



PFLEGE



SICHERHEITSHINWEISE



Hinweise zu Batterien: Batterien dürfen nicht übermäßiger Wärme ausgesetzt werden, wie Sonnenschein, Feuer oder dergleichen. Nur wiederaufladbare Batterien dürfen geladen werden. Verbrauchte Batterien dürfen laut Gesetzgeber nicht in den Hausmüll entsorgt werden. Sie sind verpflichtet sie bei einer öffentlichen Sammelstelle für Altbatterien, in einer Verkaufsstelle oder beim technischen Kundendienst kostenfrei abzugeben. Gebrauchte Batterien und Akkus weisen einen hohen Anteil an wieder verwertbaren Materialien, so genannten Wertstoffen auf. Dadurch, dass sie im Recyclingprozess zurück gewonnen werden, statt in den Abfall zu gelangen, leisten Sie einen Beitrag zur Erhaltung wichtiger Ressourcen und Sie schützen die Umwelt vor schädlichen Schwermetallen. Schadstoffhaltige Batterien sind mit einem Zeichen, bestehend aus einer durchgestrichenen Mülltonne und dem chemischen Symbol (Cd, Hg oder Pb) des für die Einstufung als schadstoffhaltig ausschlaggebenden Schwermetalls versehen. Informieren Sie sich bitte bei Ihrer Gemeinde über entsprechende Entsorgungseinrichtungen.



Für Lithium-basierte Primär- und Sekundärbatterien: Nur vollständig entladene Batterien entsorgen. Falls die Batterie nicht vollständig entladen ist müssen Vorkehrungen zur Sicherung gegen Kurzschluss getroffen werden, z.B. Isolierung der Elektroden.



ACHTUNG

Der Kauf und der Besitz der vollautomatischen Ausführung Art. Nr. 2.5945X und 2.6319X ist laut Waffengesetz in Deutschland verboten!

Sie sollten mit der richtigen, sicheren Handhabung Ihrer Waffe vertraut sein. Im Hinblick auf die Grundregeln zum sicheren Schießen bedenken Sie, dass jede Berührung mit der Waffe als Handhabung verstanden wird.

- Behandeln Sie jede Waffe so, als wäre sie geladen.
- Die Waffe beim Laden stets sichern, so dass sich kein Schuss ungewollt lösen kann.
- Finger immer außerhalb des Abzugsbügels halten und nur zum Schuss an den Abzug legen.
- Verwenden Sie nur für diese Waffe vorgesehene Geschosse.
- Halten Sie die Mündung stets in eine sichere Richtung.
- Das Schießen ist nur in der eigenen Wohnung, auf polizeilich zugelassenen Schießständen und im befriedeten Besitztum erlaubt, wenn das Geschoss dieses beim Schuss nicht verlassen kann. Hierbei den Gefahrenbereich des Geschosses beachten.
- Transportieren Sie niemals eine geladene Waffe. Laden Sie nur, wenn Sie schießen möchten.
- Waffe niemals auf Menschen oder Tiere richten. Vermeiden Sie Querschläger. Schießen Sie niemals auf glatte, harte Oberflächen oder auf Wasserflächen.
- Vergewissern Sie sich vor dem Schuss, dass Ziel und Umgebungsbereich sicher sind.
- Kontrollieren Sie immer, ob die Waffe ungeladen ist, wenn Sie sie transportieren oder von einer anderen Person übernehmen.
- Vergewissern Sie sich, dass Sie auch beim Stolpern oder Stürzen die Richtung der Mündung kontrollieren können.
- Aus Sicherheitsgründen sollte beim Schießen eine Schutzbrille getragen werden.
- Aufbewahren der Waffe stets sicher und ungeladen vor unerlaubtem Zugriff Unbefugter (ungeschulte Personen, Kinder, Personen unter 18 Jahren) und getrennt von der Munition.
- Weitergabe dieser Waffe mit der Bedienungsanleitung nur an Personen
 - die mit dieser Waffe genauestens vertraut und
 - bei Waffen mit -Zeichen mindestens 18 Jahre alt sind.
- Druckluftwaffen mit Energie > 0,5 Joule aber ohne -Zeichen sind erwerbscheinpflichtig.
- Jegliche Veränderungen oder Reparaturen von Waffen sollten nur von fachkundigen Firmen oder vom Büchsenmacher durchgeführt werden.
- Legen Sie niemals eine geladene Waffe aus der Hand.
- Geben Sie nur entladene Waffen an andere Personen weiter.

REPARATUR

Eine Waffe, die nicht einwandfrei funktioniert, ist gefährlich. Es ist schwierig, eine Waffe selbst zu reparieren, und falscher Zusammenbau kann zu gefährlichen Funktionsstörungen führen.

Achtung: Lassen Sie die Waffe nur von einem autorisiertem Fachhändler/ Büchsenmacher überprüfen und reparieren.



SICHERHEITSHINWEISE | GARANTIE

ACHTUNG

Zu Ihrer eigenen und zur Sicherheit anderer lesen Sie die Bedienungsanleitung vollständig und sorgfältig durch, bevor Sie mit der Waffe erstmalig hantieren. Käufer und Besitzer haben die Pflicht, alle Regeln über den Gebrauch und den Besitz von Druckluftwaffen zu befolgen. Jede Änderung an dieser Waffe kann zu einer Änderung der waffenrechtlichen Einstufung führen und ist somit unzulässig. Die Gewährleistung des Herstellers erlischt in diesem Fall sofort.

WARNUNG

Diese Druckluftwaffe nicht in der Öffentlichkeit zeigen oder mit ihr drohen - es führt zu Verwechslungen mit echten Waffen und gilt als Straftat. Ändern Sie keinesfalls die Farbe und Markierungen der Druckluftwaffe, um ihr Aussehen mehr einer realen Schusswaffe anzugleichen. Dies ist gefährlich und gilt als Straftat.

GARANTIE

Innerhalb des gesetzlich festgelegten Zeitraumes ab Kaufdatum repariert oder ersetzt Ihnen die Fa. UMAREX Ihre Waffe kostenlos, falls der Defekt nicht durch Eigenverschulden aufgetreten ist. Geben Sie die Waffe einem autorisierten Händler, beschreiben Sie ihm das Problem und fügen Sie den entsprechenden Kaufbeleg bei.

Die von UMAREX Sportwaffen GmbH & Co. KG hergestellten Druckluftwaffen werden gemäß den Zulassungsvorschriften der Physikalisch-Technischer Bundesanstalt (PTB), dem Bundesgesetz, den CIP-Vorschriften und dem waffentechnischen Know-how der Firma UMAREX Sportwaffen GmbH & Co. KG hergestellt.

Somit übernehmen wir keine Haftung, falls diese Ware nach dem Export ins Ausland nicht den dort geltenden Rechtsvorschriften entsprechen sollte und dem Besitzer/Käufer juristische Schwierigkeiten und Konsequenzen daraus entstehen sollten.

TECHNISCHE DATEN

Art.Nr.	2.5945	2.5945X	2.6319	2.6319X
System	Electric Airsoft			
Kaliber / Munition	6 mm BBs			
Kapazität	100 Schuss (BBs)			
Energie	1,3 J max.	1 J max.	1,3 J max.	1 J max.
Geschwindigkeit	bis 110 m/s mit 0,20 g BB	bis 100 m/s mit 0,20 g BB	bis 110 m/s mit 0,20 g BB	bis 110 m/s mit 0,20 g BB
Funktion	Semi-Auto	Semi + Voll-Auto	Semi-Auto	Semi + Voll-Auto
Kadenz	-	1000 Schuss / Min.	-	1000 Schuss / Min.
Farbe	Schwarz			
Sicherung	manuell			
Lauflänge	365 mm		420 mm	
Max. Gefahrenbereich bis zu	150 m		150 m	
Gewicht	3500 g		3793 g	
Gesamtlänge	805 mm - 886 mm		906 mm - 989 mm	



BENENNUNG

DE

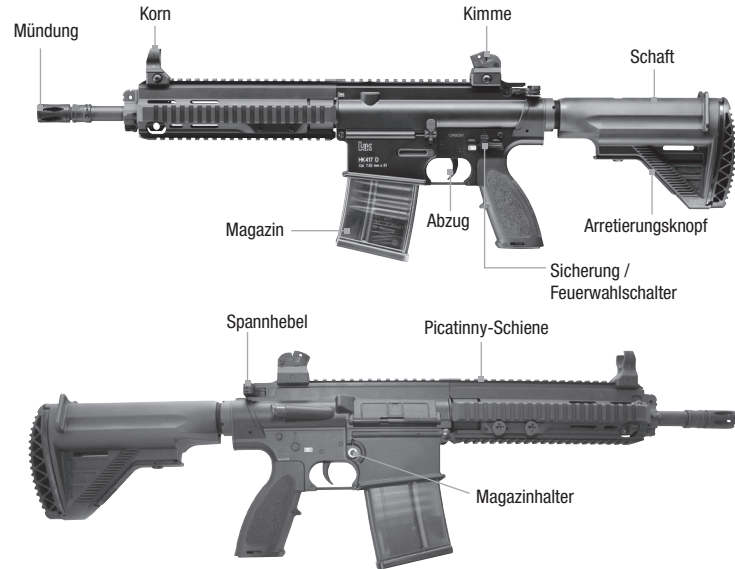



SICHERUNG

DE

⚠️ ACHTUNG

- Hantieren Sie nur mit der Waffe, wenn diese gesichert ist.
- Achten Sie stets darauf, dass die Mündung in eine sichere Richtung zeigt.



Full-Auto-Version 2.5945X / 2.6319X

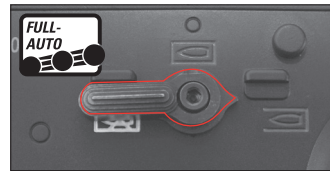
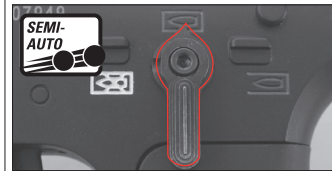

⚠️ ACHTUNG

DE In Deutschland werden die Waffen aus gesetzlichen Gründen nur als SEMIAUTO vertrieben. Bitte beachten Sie das jeweilige Waffengesetz in Ihrem Land.

Semi-Auto-Version 2.5945 / 2.6319

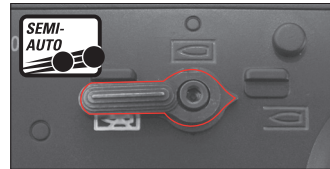
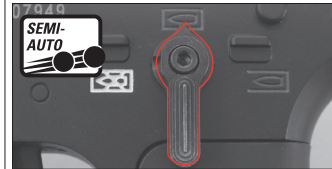

⚠️ ACHTUNG

Schalten Sie niemals, während Sie den Abzug betätigen, den Feuerwahlhebel um. Dies verursacht schwere Schäden an Ihrer Waffe.



SCHIESSEN



PROBLEMLÖSUNGEN



PROBLEME

schlechte Schussleistung							
Waffe schießt nicht	●	●	●		●	●	
geringe Geschwindigkeit			●	●	●	●	

MÖGLICHE GRÜNDE

Waffe gesichert	Magazin neu spannen	Akku / Magazin leer	Lauf verschmutzt	Extreme Temperaturen	Falsche Munition	Munition falsch geladen	Visierung nicht richtig eingestellt
			●	●	●	●	●



AKKU EINLEGEN

DE

ACHTUNG

- Bei fast leeren Akkus kann es zu Gearbox-Störungen kommen, welche reparaturbedürftig sind.
- Akkus dürfen nicht tiefentladen werden, sonst können die Zellen beschädigt werden.
- Längeres Überladen verursacht dauerhaften Schaden der Akkus.
- Akkus sollten vor dem Laden stets entladen sein.
- Auf Akkus kann keine Garantie gewährt werden, da sie Verschleißteile sind. Verwenden Sie nur eine Akkutype von mindestens 9,6 V. (z.B. Artikel-Nr.: 2.6003) (Crane Stock) oder LiPo-Akkus

Verbrauchte Batterien gehören nicht in den Hausmüll. Lassen Sie diese nur über den Fachhandel oder durch Batterie-Sammelstellen entsorgen.

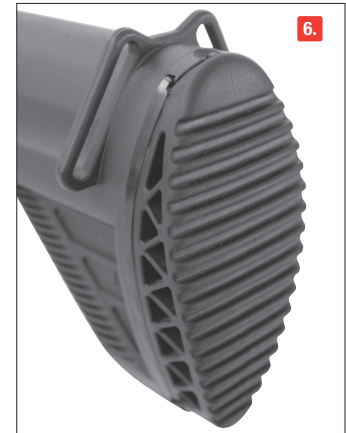
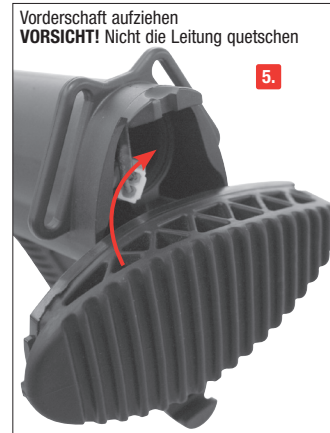



MAGAZIN LADEN

DE

⚠️ ACHTUNG



Verwenden Sie nur einwandfreie BB-Kugeln: \varnothing 6 mm. Verwenden Sie auf keinen Fall folgende BB-Kugeln: ❶ Durchmesser größer als 6 mm, ❷ mit Grat, ❸ versetzte Hälften, ❹ gebraucht, verschmutzt. Bei Gebrauch ungeeigneter Geschosse erlischt die Garantie. Empfohlen werden Präzisionsrundkugeln des Herstellers Umarex/Walther. Vermeiden Sie das Eindringen von Schmutz und Staub in das Magazin.

6 mm
AIRSOFT

WEIGHT
0,2 g BB

WEIGHT
0,25 g BB

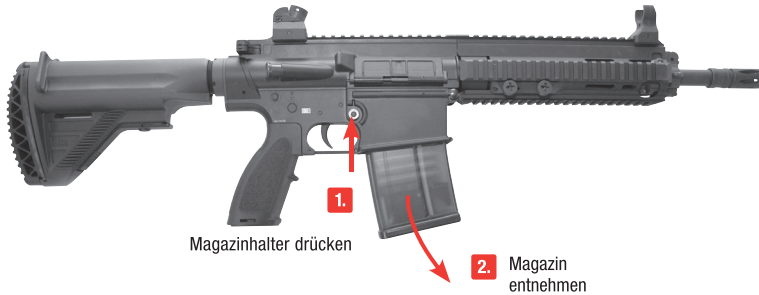

1. Magazinhalter drücken

2. Magazin entnehmen



BBs laden

4.

Öffnen

3.

Klick

5.

Drücken



Klick

7.



6.

Drücken Sie den Knopf so oft bis 100 BB's geladen sind



VISIERUNG EINSTELLEN

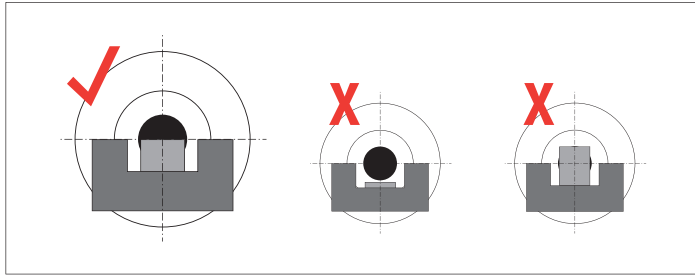

EINSTELLEN DER KIMME

2.5945 / 2.5945X

Höhenverstellung





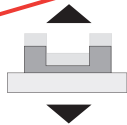

- 1: Offene Kimme
- 2: Längere Schussentfernung
- 3: Mittlere Schussentfernung
- 4: Kürzere Schussentfernung



Seitenverstellung



- Schuss zu weit links   nach rechts drehen
- Schuss zu weit rechts   nach links drehen



EINSTELLEN DER KIMME

DE

2.6319 / 2.6319X

Höhenverstellung

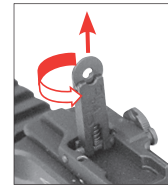

- 1. Kimme nach oben ziehen

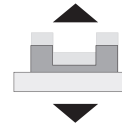

- 2. Kimme in gewünschte Richtung drehen

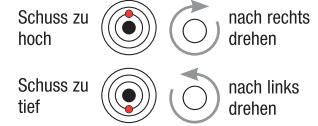

Seitenverstellung

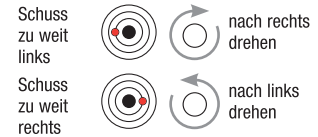



SHOOT UP EINSTELLEN

Spannhebel zurückziehen und nach vorne drücken.

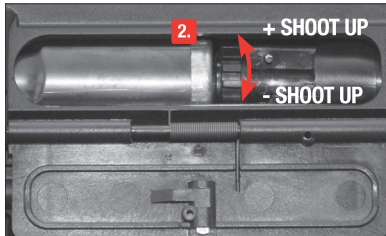

Verschlussfang drücken

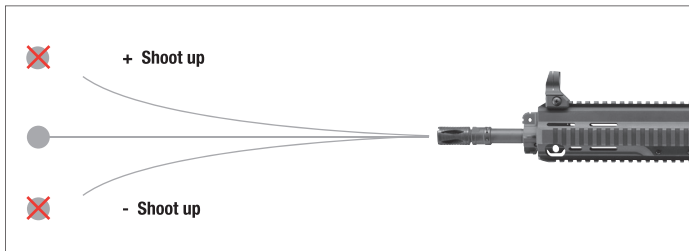

SCHAFT

DE

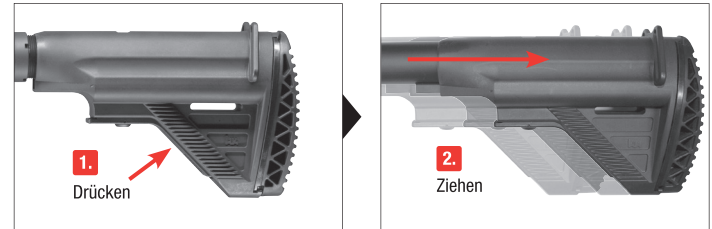

LAUFREINIGUNG



ACHTUNG

- Entladen Sie die Waffe bevor Sie die Waffe reinigen.
- Schieben Sie den Stab niemals mit Gewalt in den Lauf, dies kann Beschädigungen verursachen.
- Reinigen Sie gelegentlich die äußeren Metallteile. Benutzen Sie dazu ein Tuch, auf das Sie leicht Waffenöl aufgetragen haben.
- Geben Sie niemals das Waffenöl direkt in den Lauf.

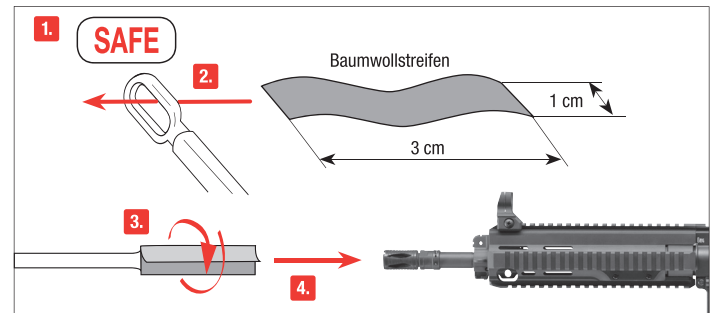

Sichern Sie die Waffe. Nehmen Sie einen ca. 60 cm dünnen, langen Stab. Wickeln Sie ein Stück Baumwolltuch um das Ende, benetzen Sie das Tuch mit etwas Waffen-Öl und reinigen Sie damit den Lauf.



MANIEMENT DES ARMES EN TOUTE SÉCURITÉ

FR



DÉSIGNATION DES PIÈCES



UTILISATION



ENTRETIEN



CONSIGNES DE SÉCURITÉ



Remarques concernant les piles : Ne pas exposer les piles à une source de chaleur trop importante, comme par exemple aux rayons du soleil, au feu ou semblables. Ne recharger que des piles rechargeables. La loi interdit de jeter les piles usées dans les ordures ménagères. Vous êtes tenus de les rapporter à un centre public de collecte des piles usagées, à un lieu de vente ou au service après-vente technique où elles sont récupérées à titre gratuit. Les piles et accus usagés contiennent un haut pourcentage de matériaux valorisables également appelés matériaux recyclables. Étant donné que ces matériaux sont récupérés pendant le processus de recyclage au lieu d'être éliminés avec les autres déchets, vous contribuez à conserver des ressources importantes et protéger l'environnement des métaux lourds toxiques et nocifs pour l'environnement. Les piles contenant des produits toxiques sont identifiées par un symbole représentant une poubelle barrée et le symbole chimique du métal lourd (Cd, Hg ou Pb) décisif pour la classification comme contenant des produits toxiques. Veuillez vous renseigner auprès de votre commune sur les points de collecte appropriés. Consultez le manuel du produit pour savoir comment enlever les piles.

Pour les piles primaires et secondaires à base de lithium : Ne mettre au rebut que des piles entièrement déchargées. Si la pile n'est pas entièrement déchargée, il est nécessaire de prendre des mesures préventives afin de la protéger de tout court-circuit, par ex. par une isolation des électrodes.

Vous devez savoir manier votre arme correctement et de manière sûre et devez impérativement respecter les règles de base de tir en toute sécurité à chaque fois que vous manipulez l'arme.

- Maniez toujours l'arme comme si elle était chargée.
- Mettez toujours la sécurité avant de charger l'arme afin d'éviter tout tir involontaire.
- Ne mettez pas le doigt sur la détente et ne l'y placez que lorsque vous allez tirer.
- N'utilisez que les projectiles prévus pour cette arme.
- Pointez toujours la bouche de l'arme dans une direction non dangereuse.
- Il n'est permis de tirer avec l'arme que sur le lieu de résidence du propriétaire ou dans des zones de tir autorisées par la police, à condition que le projectile ne puisse pas sortir de la zone de tir. Veuillez toujours prendre en compte la zone de danger maximale du projectile.
- Ne transportez jamais l'arme lorsqu'elle est chargée. Ne la chargez que lorsque vous vous apprêtez à tirer.
- Ne dirigez jamais l'arme vers des personnes ni des animaux. Evitez les tirs pouvant faire ricocher le projectile. Ne tirez jamais sur des surfaces planes et dures, ni sur une surface d'eau car les projectiles peuvent ricocher.
- Avant de tirer, assurez-vous que l'objectif et les alentours ne présentent pas de danger.
- Vérifiez toujours que l'arme est déchargée avant de la transporter ou de la remettre à autrui.
- Veillez à maîtriser la direction dans laquelle la bouche de l'arme est pointée, même si vous trébuchez ou tombez.
- Pour des raisons de sécurité, portez des lunettes de protection lorsque vous tirez.
- Rangez toujours l'arme déchargée, séparée des munitions et dans un endroit sûr afin d'éviter que des personnes non autorisées (personnes non formées, enfants) puissent y avoir accès.
- Ne remettez cette arme, accompagnée du mode d'emploi, qu'à des personnes
 - qui sont le plus possible formées au maniement de cette arme et
 - qui ont atteint l'âge minimum légal selon la loi sur les armes en vigueur dans votre pays.
- Toute modification ou réparation de l'arme devra être effectuée par une entreprise spécialisée ou un armurier.
- Ne laissez jamais l'arme chargée sans surveillance.
- Déchargez toujours l'arme avant de la remettre à autrui.

RÉPARATION

Une arme qui ne fonctionne pas parfaitement est dangereuse. Il est difficile de réparer une arme soi-même, et un remontage incorrect peut entraîner des dysfonctionnements dangereux.

Attention : Seules des personnes spécialisées agréées ou un armurier peuvent contrôler et réparer l'arme.

Cette boîte contient: une réplique d'arme factice avec chargeur. Les AIRSOFT GUNS sont des modèles d'armes factices tirant des billes en plastique de 6 mm inoffensives. Ce modèle a une énergie comprise entre 0,08 joule et inférieure ou égale à 2 joules. **En France, la vente de ces produits est réglementée par le décret n°99-240 du 24 mars 1999, qui interdit la distribution des modèles noirs ou chromés dont l'énergie est comprise entre 0,08 et 2 joules aux moins de 18 ans non accompagnés. Ce décret ne concerne pas les modèles transparents, les game guns (orange) et les mini guns, dont la distribution reste donc autorisée aux mineurs.**

- Distribution et vente interdite aux mineurs. • Attention: Ne jamais diriger le tir vers une personne.



CONSIGNES DE SÉCURITÉ | GARANTIE



ATTENTION

Pour votre sécurité et celle d'autrui, lisez attentivement le mode d'emploi avant d'utiliser l'arme pour la première fois. Les vendeurs, tout comme les acheteurs, ont l'obligation de respecter le règlement relatif à l'utilisation et à la possession d'armes à air comprimé.

Il est interdit de procéder à toute modification de ce pistolet car cela pourrait entraîner un changement dans la classification correspondant à la législation sur les armes à feu. De plus, toute modification entraînerait l'annulation immédiate de la garantie du fabricant.



MISE EN GARDE

N'exhibez pas cette arme à air comprimé et ne la sortez pas en public. Cela pourrait prêter à confusion ou être considéré comme un délit. Les membres des forces de sécurité et la police pourraient la prendre pour une vraie arme à feu. Ne changez pas sa couleur ni les éléments d'identification pour qu'elle ressemble plus à une vraie arme à feu. Cela serait dangereux et peut être considéré comme un délit.

GARANTIE

La société UMAREX s'engage à réparer ou à remplacer votre arme durant une période déterminée légalement à compter de la date d'achat, à condition que vous ne soyez pas responsable du défaut. Pour cela, remettez l'arme à un revendeur autorisé, décrivez-lui le problème et joignez le justificatif d'achat correspondant.

Les armes à air comprimé de la société UMAREX Sportwaffen GmbH & Co. KG sont fabriquées conformément aux directives de conformité de l'institut allemand « Physikalisch-Technische Bundesanstalt (PTB) », à la loi fédérale, aux prescriptions CIP et au savoir-faire technique de la société UMAREX Sportwaffen GmbH & Co. KG dans le domaine des armes.

Ainsi, nous ne pouvons être tenus responsables si, après exportation à l'étranger, cette marchandise ne répond pas aux prescriptions légales en vigueur dans le pays en question et si le possesseur/acheteur doit pour cette raison faire face à des difficultés juridiques ou toute autre conséquence pouvant découler de ce fait.

DONNÉES TECHNIQUES

Numéro d'article	2.5945	2.5945X	2.6319	2.6319X
Système	Electric Airsoft			
Calibre / Munitions	6 mm BBs			
Capacité	100 Coups (BBs)			
Énergie	1,3 J max.	1 J max.	1,3 J max.	1 J max.
Vitesse	jusqu'à 110 m/s avec 0,20 g BB	jusqu'à 100 m/s avec 0,20 g BB	jusqu'à 110 m/s avec 0,20 g BB	
Action	Semi-Auto	Semi + Voll-Auto	Semi-Auto	Semi + Voll-Auto
Cadence	-	1000 Coups / Min.	-	1000 Coups / Min.
Couleur	noir			
Sécurité	manuel			
Longueur canon	365 mm		420 mm	
Zone de danger s'étendant	150 m		150 m	
Poids	3500 g		3793 g	
Longueur	805 mm - 886 mm		906 mm - 989 mm	



DÉSIGNATION DES PIÈCES

FR

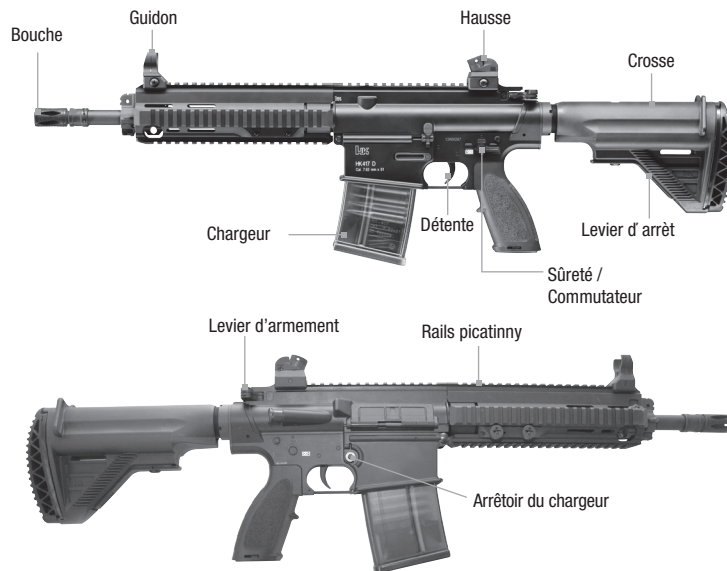



SÉCURITÉ

FR

ATTENTION

- Ne manipulez l'arme que lorsque la sécurité est enclenchée.
- Assurez-vous que la bouche est orientée dans une direction non dangereuse.



Version entièrement automatique 2.5945X / 2.6319X

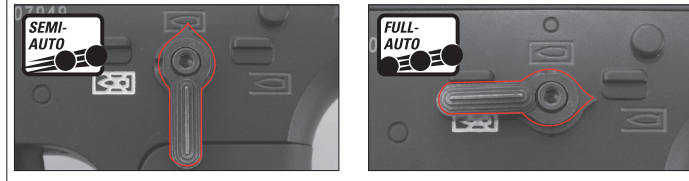

ATTENTION

Veillez à respecter la législation sur les armes en vigueur dans votre pays !

Version semi automatique 2.5945 / 2.6319



ATTENTION

Pendant activer la détente, ne commutez jamais le commutateur. Cela cause des dommages graves.



TIR



DYSFONCTIONNEMENTS



DYSFONCTIONNEMENTS

- mauvaise performance de tir
- l'arme ne tire pas
- faible vitesse du projectile

CAUSES POSSIBLES

	sécurité de l'arme enclenchée	Chargeur pour serrer	L'accu / Chargeur vide	canon encrassé	températures extrêmes	mauvaises munitions	munitions mal chargées	dispositif de visée mal réglé	
mauvaise performance de tir				●	●	●	●	●	
l'arme ne tire pas	●	●	●			●	●		
faible vitesse du projectile				●	●	●	●		



INSÉRER L'ACCU

FR

ATTENTION

- Si les accus sont presque vides, des perturbations au niveau de la transmission pourraient en résulter qui rendent nécessaire une réparation.
- Il ne faut pas décharger complètement les accus. Sinon, les cellules risquent d'être abîmées.
- Toute surcharge de longue durée est susceptible d'abîmer les accus durablement.
- Avant tout chargement, il faudrait que les accus soient toujours déchargés.
- Nous ne pouvons pas accorder de garantie pour les accus, car ceux-ci représentent des pièces d'usure. Veuillez utiliser seulement le type d'accu ayant de du moins 9,6 V. (p.ex. numéro d'article: 2.6003) (Crane Type) ou LiPo accus

Vous ne devez pas jeter les piles usagées dans le conteneur à ordures ménagères. Déposez les dans des commerces spécialisés ou à des points de collecte de piles.

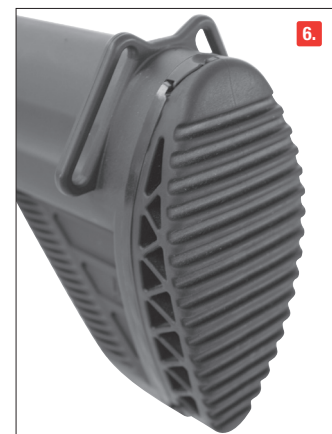
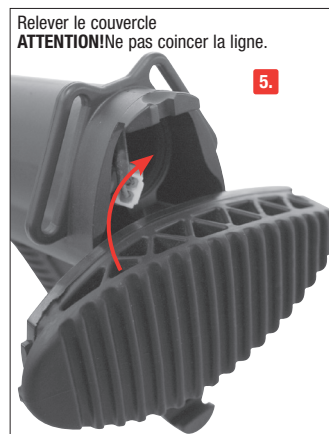



CHARGEMENT DES BILLES BB

FR

⚠ ATTENTION

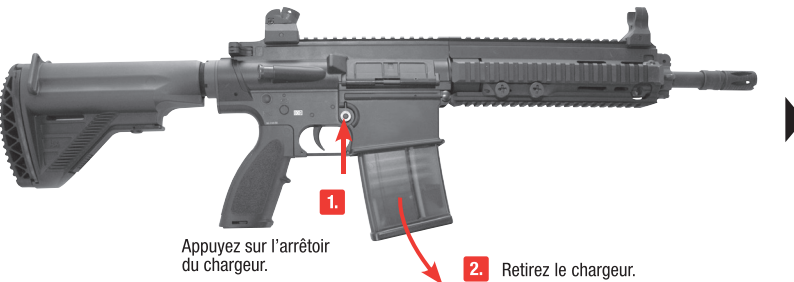
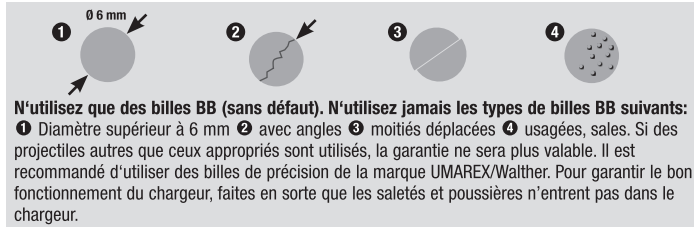



HAUSSE

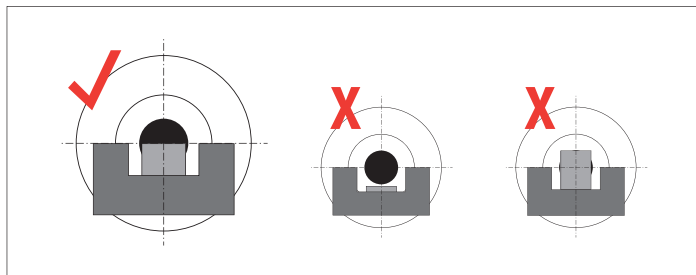

AJUSTAGE LA HAUSSE

2.5945 / 2.5945X

Réglage en hauteur

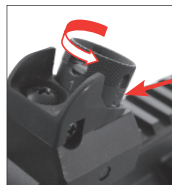



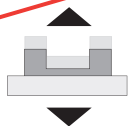

- 1 : Cran de mire ouvert
- 2 : Tir longue distance
- 3 : Tir moyenne distance
- 4 : Tir courte distance



Réglage latéral



- Tir trop à gauche   tourner vers la droite
- Tir trop à droite   tourner vers la gauche



AJUSTAGE LA HAUSSE

FR

2.6319 / 2.6319X

Réglage en hauteur

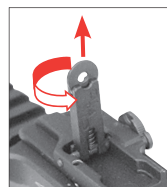

1. Tirez Hausse

2. Tourner Hausse

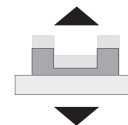

Tir trop haut
Tir trop bas



tourner vers la droite
tourner vers la gauche

Réglage latéral



Tir trop à gauche
Tir trop à droite



tourner vers la droite
tourner vers la gauche



AJUSTAGE SHOOT UP

Tirer le levier de chargement vers l'arrière et le pousser vers l'avant.

1.

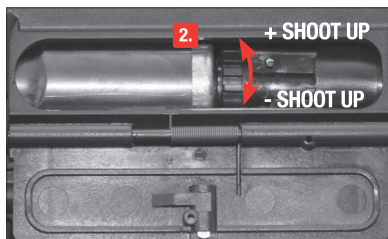

2.

+ SHOOT UP

- SHOOT UP

Appuyez

3.

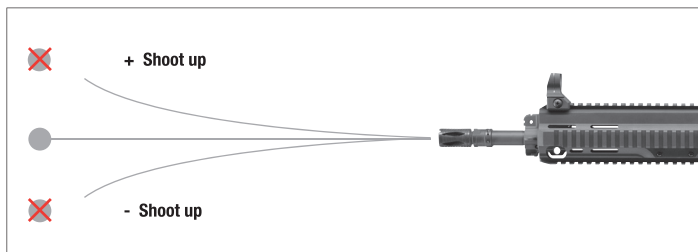

CROSSE

FR

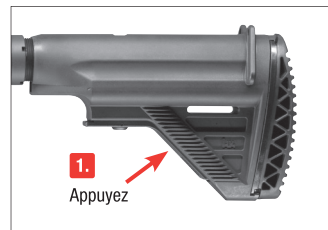

1.

Appuyez

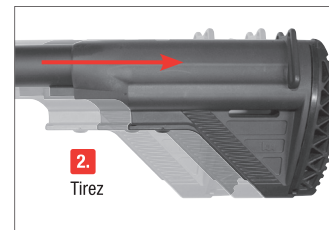

2.

Tirez



NETTOYAGE DE CANON



ATTENTION

- Déchargez l'arme avant de nettoyer l'arme.
- N'enfoncez pas la bague de nettoyage violemment dans le canon, car elle pourrait l'endommager.
- Nettoyez les pièces métalliques extérieures à l'aide d'un chiffon doux préalablement imbibé d'huile pour armes.
- Ne versez jamais l'huile de silicone directement dans le canon.

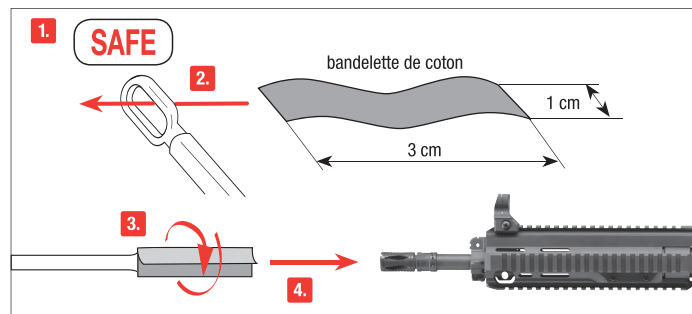

Mettez la sécurité de l'arme. Utilisez une tige fine d'une longueur d'env. 30 cm. Enroulez une bandelette de coton à son extrémité et nettoyez le canon avec une petite quantité d'huile de silicone.



MANEJO SEGURO DE ARMAS

ES



DESIGNACION



REGLAJE



CUIDADOS



INSTRUCCIONES DE SEGURIDAD



Nota sobre las pilas: No se puede exponer las pilas a un calor excesivo como la radiación solar, fuego o similares. Sólo se puede cargar las pilas recargables. Conforme a la legislación vigente no se puede tirar las pilas usadas a la basura doméstica. El usuario está obligado a llevarlas gratuitamente a un punto de recogida público para pilas usadas, un centro de ventas o al servicio técnico. Las pilas y baterías usadas contienen un alto porcentaje de sustancias reutilizables, denominado material reciclable. Al ser recuperado en el proceso de reciclaje, y no tirado a la basura, Usted contribuye a la conservación de importantes recursos y a proteger el medio ambiente contra los metales pesados tóxicos. Las pilas que contienen sustancias tóxicas están marcadas con un símbolo consistente en un cubo de basura tachado y el símbolo químico (Cd, Hg o Pb) del metal pesado responsable de su clasificación como pila tóxica. Por favor, infórmese en su municipio de los centros de eliminación respectivos. Las instrucciones para retirar las pilas figuran en el manual del producto.

Relativo a las pilas primarias y secundarias a base de litio: Eliminar sólo las pilas totalmente descargadas. Si la pila no está totalmente descargada deberán tomarse precauciones para asegurarla contra un cortocircuito, p. ej. aislar los electrodos.

Deberá estar familiarizado con el manejo correcto y seguro de su arma. Con respecto a las reglas básicas para disparar con seguridad, considere cada contacto con el arma como parte de su manejo.

- Trate el arma como si siempre estuviera cargada.
- Cargue siempre el arma con el seguro activado para evitar disparos involuntarios.
- Mantenga el dedo siempre fuera del gatillo y colóquelo solamente cuando vaya a disparar.
- Utilice únicamente proyectiles específicos para esta arma.
- Mantenga la boca del arma siempre en una dirección segura.
- Sólo está permitido disparar el arma en la vivienda del propietario o en las zonas de tiro autorizadas por la policía, siempre y cuando el proyectil no pueda llegar más allá del área de tiro. Para ello, tenga presente siempre la distancia máxima de peligro del proyectil.
- Nunca transporte el arma cargada. Cárguela solamente cuando tenga intención de disparar.
- Nunca apunte con el arma hacia personas o animales. Evite los disparos en los que el proyectil pueda rebotar: nunca dispare sobre superficies lisas y duras, ni al agua.
- Antes de disparar, asegúrese que el blanco y el entorno sean seguros.
- Antes de transportar el arma o de recibirla de manos de otra persona compruebe siempre que está descargada.
- Asegúrese de que, aunque tropezara o cayera, todavía puede controlar la dirección a la que apunta la boca del arma.
- Por motivos de seguridad, cuando vaya a disparar póngase siempre gafas protectoras.
- Guarde el arma siempre descargada, separada de la munición y en lugar seguro para evitar que personas no autorizadas (personas sin formación, personas menores de 18 años, niños) puedan acceder a ella.
- Entregue esta arma, junto con las instrucciones de uso, únicamente a aquellas personas que:
 - estén perfectamente familiarizadas con el manejo de esta arma
 - hayan cumplido la edad mínima correspondiente fijada por la legislación en materia de armas del país respectivo.
- Cualquier modificación o reparación del arma deberá llevarla a cabo una empresa especializada o un armero.
- Nunca deje sin vigilancia un arma cargada.
- Siempre que entregue un arma a otra persona, asegúrese de que está descargada.

REPARACIONES

Una arma que no funcione perfectamente es peligrosa. Es difícil reparar uno mismo un arma, y un ensamblaje incorrecto puede producir anomalías de funcionamiento peligrosas.

Atención: La comprobación y reparación del arma sólo pueden llevarla a cabo especialistas autorizados o un armero.



INSTRUCCIONES DE SEGURIDAD | GARANTÍA



ATENCIÓN

Por su propia seguridad y la de los demás, lea detenidamente las instrucciones de uso antes de disparar el arma por primera vez. Vendedores y compradores están obligados a cumplir con las normas de uso y posesión de armas de aire comprimido. Queda prohibida cualquier modificación de esta arma, ya que ello podría implicar un cambio en su clasificación legal. En caso de modificación quedaría extinguida de inmediato la garantía del fabricante.



AVISO

No porte o muestre este arma de aire comprimido en público. Puede ser motivo de confusiones e ilegal. Miembros de las fuerzas de seguridad y la policía pueden tomarla por un arma de fuego real. No modifique el color ni los elementos identificativos para hacer que se parezca más a un arma de fuego real. Es peligroso y puede ser un delito.

GARANTÍA

La empresa UMAREX se responsabiliza de reparar o sustituir su producto sin coste alguno en el plazo legalmente fijado a partir de la fecha de compra, siempre que el defecto no sea responsabilidad del propio usuario. Entregue el arma a un comerciante autorizado, descríbalo el problema y adjunte el correspondiente comprobante de compra.

Las armas de aire comprimido de la empresa UMAREX Sportwaffen GmbH & Co. KG se fabrican de conformidad con las normas de homologación del Instituto Federal PTB (Physikalisch-Technischer Bundesanstalt), con la Ley Federal alemana, la normativa que establece el centro CIP y la experiencia en fabricación de armas de UMAREX Sportwaffen GmbH & Co. KG.

Por eso, no asumimos ninguna responsabilidad en el caso de que al exportar el arma a un país extranjero, ésta no cumpliera con la normativa legal local y el propietario o comprador tuviera que responder jurídicamente por dicho incumplimiento.

DATOS TÉCNICOS

Número de artículo	2.5945	2.5945X	2.6319	2.6319X
Sistema	Electric Airsoft			
Kaliber / Munición	6 mm BBs			
Capacidad	100 Tiros (BBs)			
Energía	1,3 J max.	1 J max.	1,3 J max.	1 J max.
Velocidad	hasta 110 m/s con 0,20 g BB	hasta 100 m/s con 0,20 g BB	hasta 110 m/s con 0,20 g BB	hasta 110 m/s con 0,20 g BB
Sistema de funcionamiento	Semi-Auto	Semi + Voll-Auto	Semi-Auto	Semi + Voll-Auto
Cadencia	-	1000 Tiros / Min.	-	1000 Tiros / Min.
Color	negro			
Seguro	manual			
Longitud del cañón	365 mm		420 mm	
Distancia máxima de peligro	150 m		150 m	
Peso	3500 g		3793 g	
Longitud	805 mm - 886 mm		906 mm - 989 mm	



DESIGNACION

ES





SEGURO

ES

⚠️ ATENCIÓN

- Manipule la pistola sólo cuando esté asegurada.
- Asegúrese de que la boca apunte siempre en una dirección segura.



Versión disparo completamente automático 2.5945X / 2.6319X

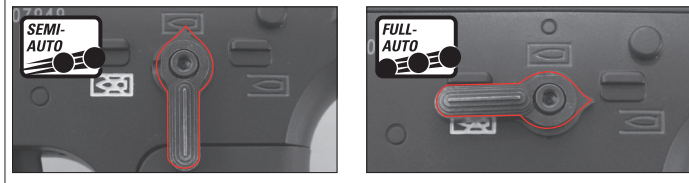

⚠️ ATENCIÓN

Rogamos observe en todo caso la legislación vigente en su país sobre el uso de armas.

Versión semi automático 2.5945 / 2.6319



⚠️ ATENCIÓN

Durante implicar el gatillo nunca conmute el conmutador. Esto causa daños graves.



DISPARO



PROBLEMAS



PROBLEMAS

Potencia de disparo deficiente

El arma no dispara

Escasa velocidad de disparo

POSIBLES CAUSAS

	Seguro activado	Cargador nuevo poner delante	La batería / Cargador vaciar	Cañón sucio	Temperaturas extremas	Munición errónea	Munición mal cargada	La mira no está bien ajustada	
Potencia de disparo deficiente				●	●	●	●	●	
El arma no dispara	●	●	●			●	●		
Escasa velocidad de disparo				●	●	●	●		



INTRODUZCA LA BATERÍA

ES

⚠ ATENCIÓN

- En caso de que la batería esté vacía, pueden producirse daños en la caja de mando que necesitarán una reparación.
 - No se deben descargar totalmente las baterías, ya que se podrían dañar los elementos.
 - La sobrecarga duradera ocasiona averías permanentes en las baterías.
 - Las baterías siempre deben estar descargadas antes de su carga.
 - En las baterías no se ofrece ninguna garantía ya que se trata de piezas consumibles.
- Use solamente el tipo de batería de al menos 9,6 V. (por ejemplo número de artículo: 2.6003) (Smal Type) o LiPo baterías

Las pilas usadas no deben tirarse en el contenedor de basura doméstico. Deséchelas en comercios especializados o en puntos de recogida de pilas.

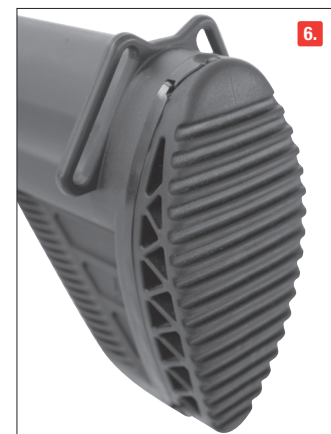
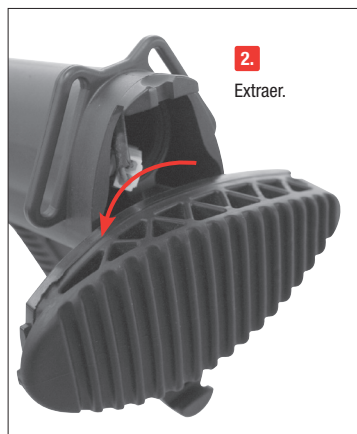



CHARGER DEL CARGADOR

ES

⚠ ATENCIÓN

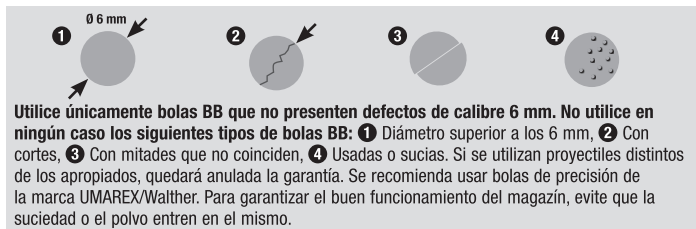



MIRA

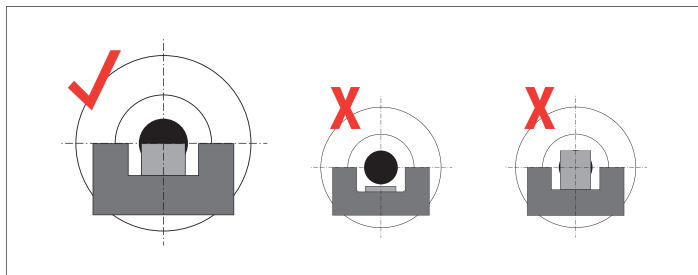

AJUSTE DE MIRA

2.5945 / 2.5945X



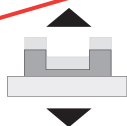
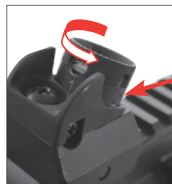

Ajuste en altura



- 1: alza abierta
- 2: distancia de tiro larga
- 3: distancia de tiro media
- 4: distancia de tiro corta

Ajuste lateral



- Disparo desviado hacia la izquierda   gire hacia la derecha
- Disparo desviado hacia la derecha   gire hacia a la izquierda



AJUSTE DE MIRA

ES

2.6319 / 2.6319X

Ajuste en altura

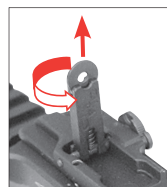

- 1. Tire mira trasera
- 2. Gire hacia mira trasera

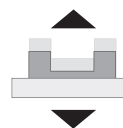

Disparo muy alto



gire hacia la derecha

Disparo muy bajo



gire hacia a la izquierda

Ajuste lateral



Disparo desviado hacia la izquierda



gire hacia la derecha

Disparo desviado hacia la derecha



gire hacia a la izquierda



AJUSTE DE SHOOT UP

Tire hacia atrás la palanca de armado y presiónela hacia delante.

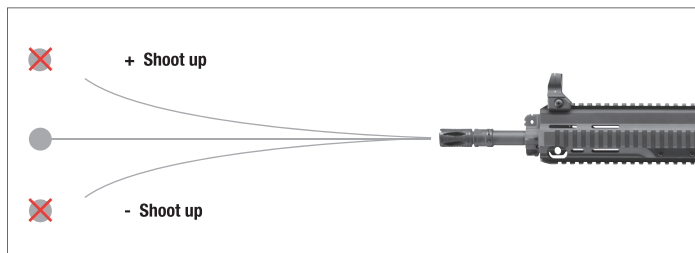
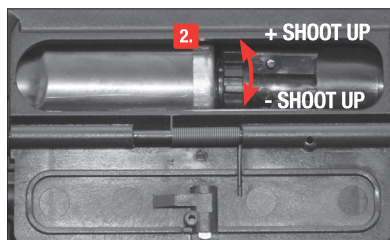

CULATA

ES

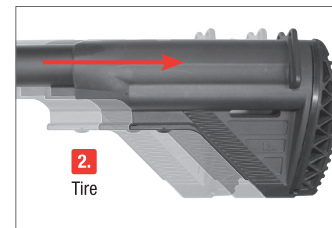
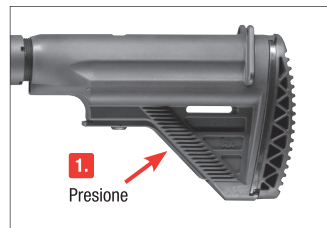

LA LIMPIEZA DE CAÑÓN



ATENCIÓN

- Descargue el arma antes de limpiar el arma.
- No debe forzar la varilla de limpieza para introducirla dentro del cañón, porque podría dañar el arma.
- Limpie las piezas metálicas exteriores con un trapo suave, humedecido con aceite para armas.
- No vierta nunca aceite de silicona directamente dentro del cañón.

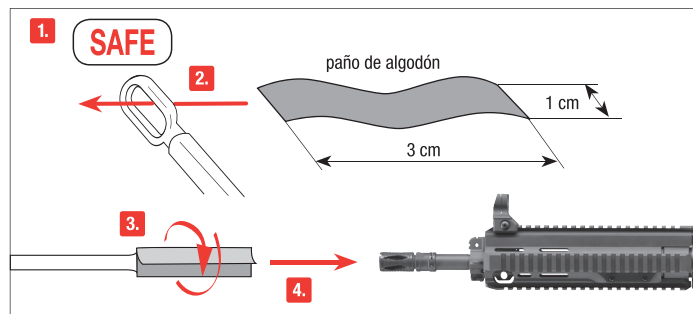

Asegure el arma. Coja una barra estrecha y larga de unos 30 cm. Enrolle un paño de algodón por el extremo, humedézcalo con un poco de aceite para armas y limpie el cañón con ayuda del mismo.

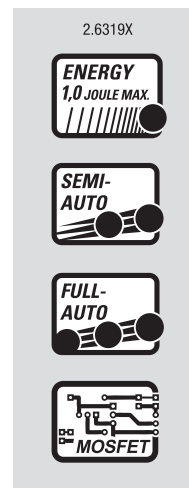
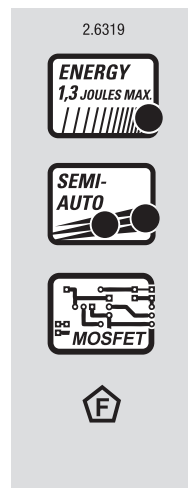
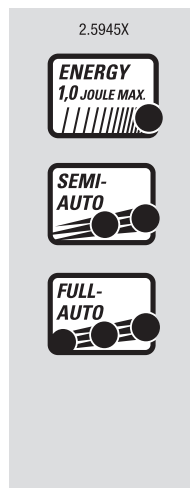
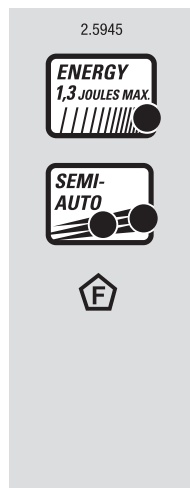
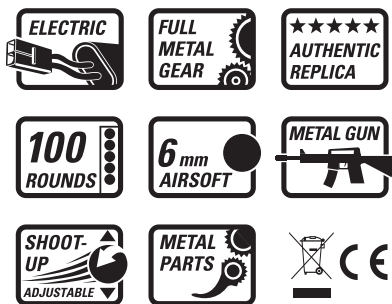

UMAREX®

UMAREX Sportwaffen GmbH & Co. KG

Donnerfeld 2

59757 Arnsberg | Germany

Phone: +49 29 32 / 638-01

Fax: +49 29 32 / 638-222

verkauf@umarex.de | sales@umarex.de

www.umarex.com

We reserve the right to make color and design changes and technical improvements. No responsibility is accepted for printing errors or incorrect information.

Änderungen in Farbe und Design, sowie technische Verbesserungen, Druckfehler und Irrtum vorbehalten. Alle Angaben ohne Gewähr.

Sauf modifications de la couleur et du design ainsi que des améliorations techniques, erreurs d'impression et erreur. Toutes les données sont fournies sans garantie.

Salvo modificaciones de color y de diseño así como mejoramientos técnicos, erratas y error. Todos los datos sin garantía.

© UMAREX Sportwaffen GmbH & Co. KG